

# CATALOGUE X1/X2

XINIX<sup>®</sup>  
DOOR SYSTEMS

20

19

UNIVERSAL SYSTEMS FOR **FRAMELESS DOORS**





## **FRAME DETAILS**

TECHNICAL INFORMATION	4
FIXING PROFILE TYPES	9
CERTIFICATION	9
FRAME TYPES	10
WALL COVERING POSSIBILITIES	13
VENTILATION GAPS	15

## **HARDWARE RANGE**

STANDARD HINGES	16
HINGES FOR SPECIAL WALLCOVERINGS	21
MAGNETIC DOOR LOCKS	22
HANDLE FREE SOLUTIONS	25
DOOR LOCKING SYSTEM	27
INTEGRATED DOOR CLOSERS	28
FINISHING PROFILE	32
PUSH & GO	33

## **FINISHING DETAILS**

DOOR HANDLES AND ACCESSORIES	36
UNIVERSAL INTEGRATED PLINTH	42
EXPLODED VIEW FOR INSTALLATION	44

# X1 - TECHNICAL INFORMATION

EU LEFT



CLOCKWISE

UNIVERSAL INSTALLATION  
FOR ANY:  
WALL TYPE  
WALL THICKNESS  
WALL FINISH

1 XINNIX FRAME + 1 DOOR = 2 POSITIONS



INSTALLATION **PULL** EU LEFT

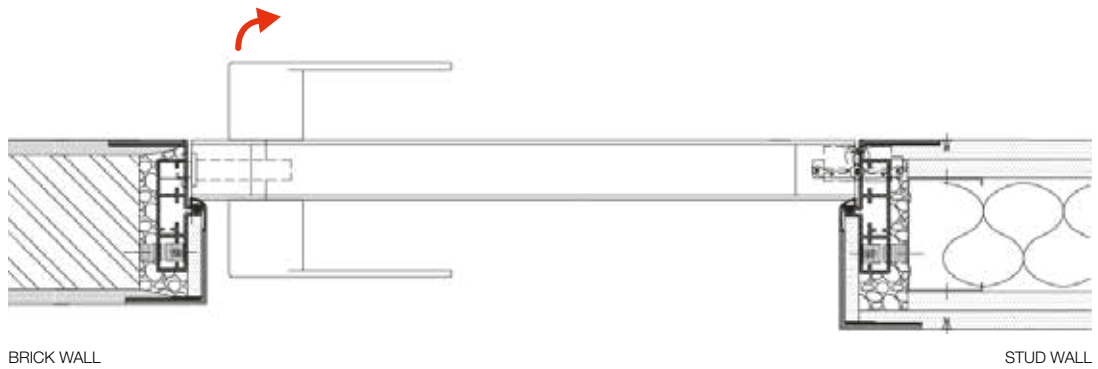

BRICK WALL

STUD WALL

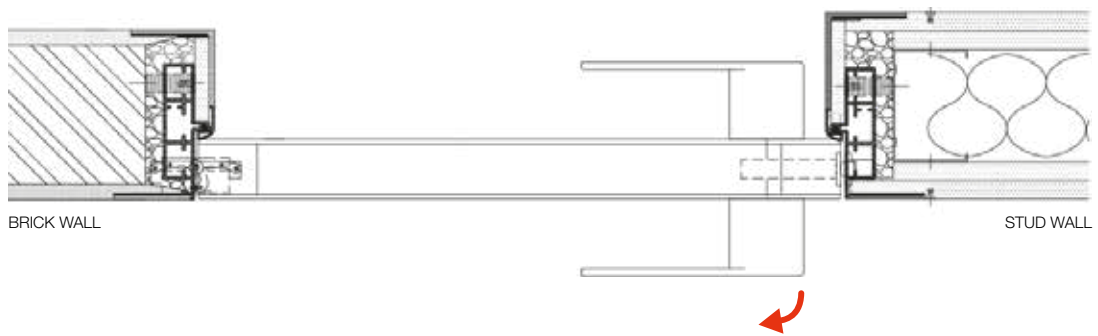

BRICK WALL

STUD WALL



# X1 - TECHNICAL INFORMATION

EU RIGHT



COUNTER CLOCKWISE

UNIVERSAL INSTALLATION  
FOR ANY:  
WALL TYPE  
WALL THICKNESS  
WALL FINISH

1 XINNIX FRAME + 1 DOOR = 2 POSITIONS



INSTALLATION **PULL** EU RIGHT

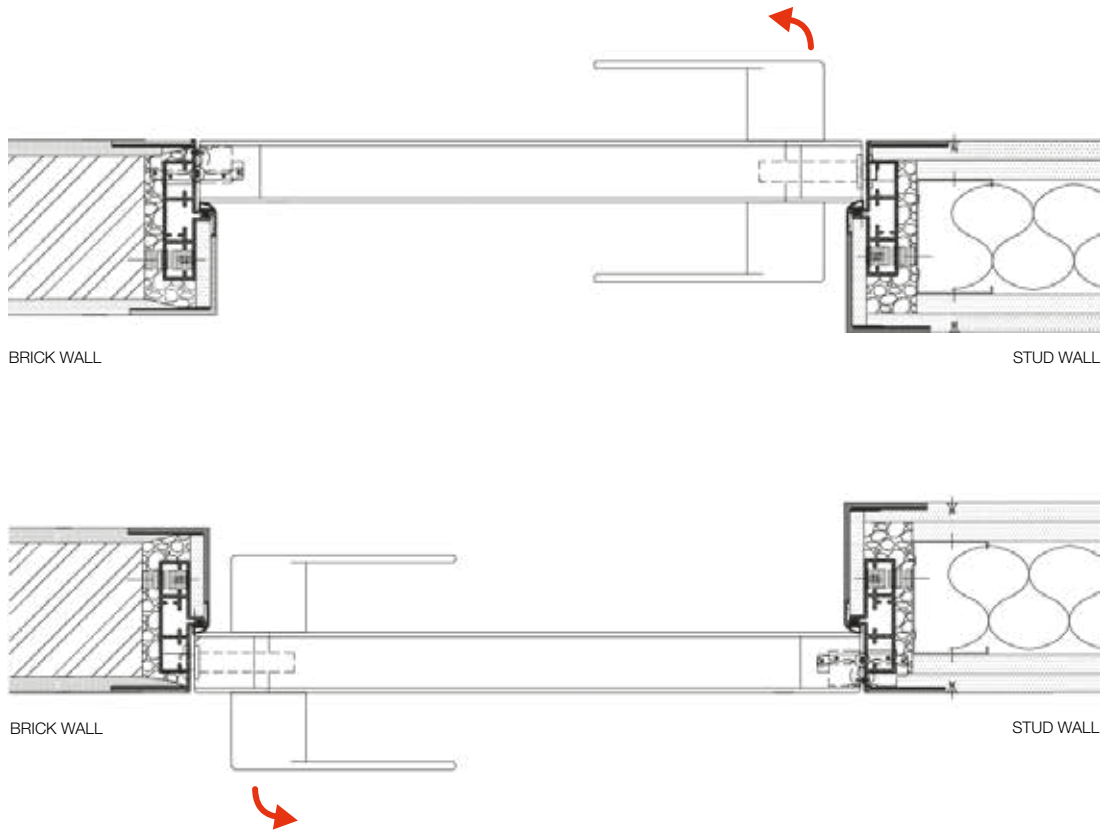



EU LEFT

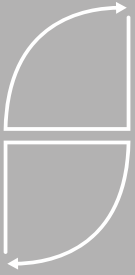

CLOCKWISE  
UNIVERSAL INSTALLATION FOR  
ANY:  
WALL TYPE  
WALL THICKNESS  
WALL FINISH

1 XINNIX FRAME + 1 DOOR = 4 POSITIONS



INSTALLATION **PULL** EU LEFT



INSTALLATION **PUSH** EU LEFT





EU RIGHT

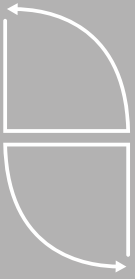

COUNTER CLOCKWISE  
UNIVERSAL INSTALLATION FOR  
ANY:  
WALL TYPE  
WALL THICKNESS  
WALL FINISH

1 XINNIX FRAME + 1 DOOR = 4 POSITIONS



INSTALLATION **PULL** EU RIGHT



INSTALLATION **PUSH** EU RIGHT



# X1 - TECHNICAL INFORMATION

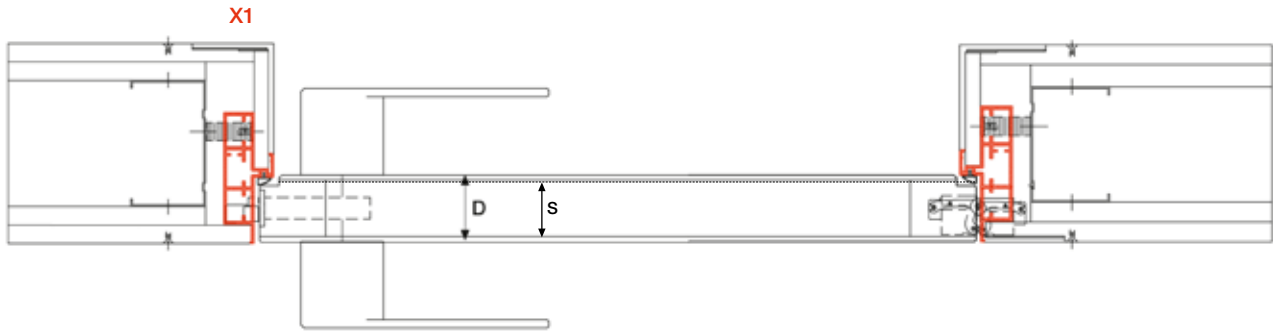

PROFILE TYPE	DOOR SIZE <b>S</b> PULL UNREBATED DOOR	DOOR SIZE <b>D</b> PULL/PUSH REBATED DOOR	MIN. WALL THICKNESS		WHITE	BLACK
			FU	FUL		
X1	40 mm	50 mm	75 mm	100 mm	•	MOQ

# X2 - TECHNICAL INFORMATION

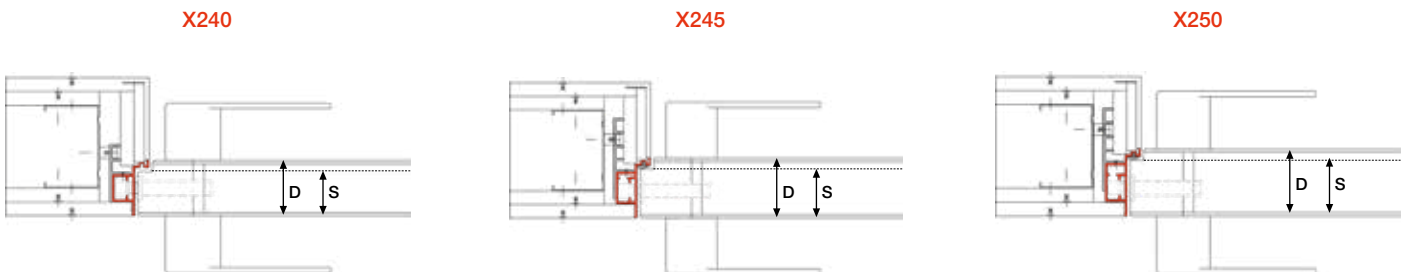

PROFILE TYPE	DOOR SIZE <b>S</b> PULL UNREBATED DOOR	DOOR SIZE <b>D</b> PULL/PUSH REBATED DOOR	MIN. WALL THICKNESS		WHITE	BLACK
			FU	FUL		
X240	40 mm	50 mm	75 mm	100 mm	•	•
X245	44-45 mm	55 mm	80 mm	125 mm	•	•
X250	50 mm	60 mm	85 mm	125 mm	•	MOQ



## X2 - FIXING PROFILE TYPES

FU



- FU: Universal Fixation profile**
- Frame with 3 hinges
  - Finished wall thickness starting from 75 mm

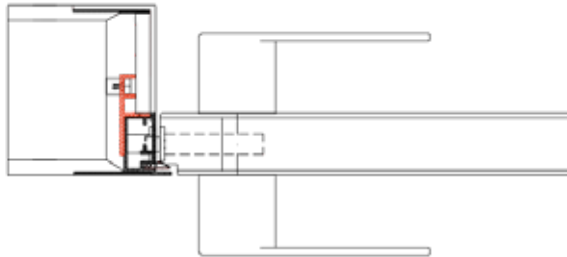

FUL



- FUL: Universal fixation profile (Large)**
- Frames with 4 or more hinges
  - Minimum wall thickness starting from 100 mm
  - Heavy duty doors (+80kg)

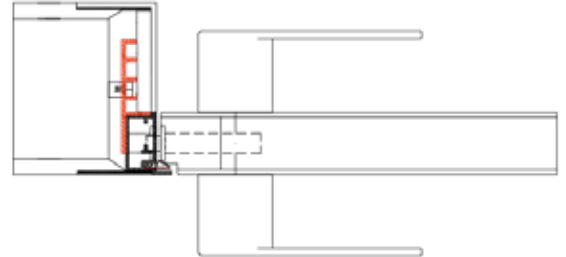

## X2 - CERTIFICATION

- EN 1191** Our frames have passed an opening and closing test during 200.000 cycles.  
(Executed with a 2800 x 830 x 50 mm door)
- EN 1634-1:2008** Our frames have passed several tests according to the European standards for fire rated certifications. Frames are available in EI<sub>1</sub>30, EI<sub>1</sub>45 and EI<sub>2</sub>60 for single doors and EI<sub>1</sub>30 and EI<sub>2</sub>45 for double doors with a large range on hardware solutions.
- ISO 10140-2:2010** Our frames have passed acoustic testing according to the international ISO standard for sound insulation in building and building elements.

Details about certified doors: see catalogue X2 certified.



# X1/X2 - FRAME TYPES

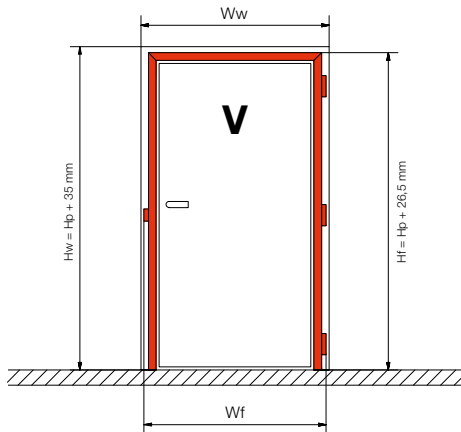

Load capacity <80 kg

$Wf = Wp + 55$

$Ww = Wp + 70$

Load capacity >80 kg

$Wf = Wp + 70$

$Ww = Wp + 85$

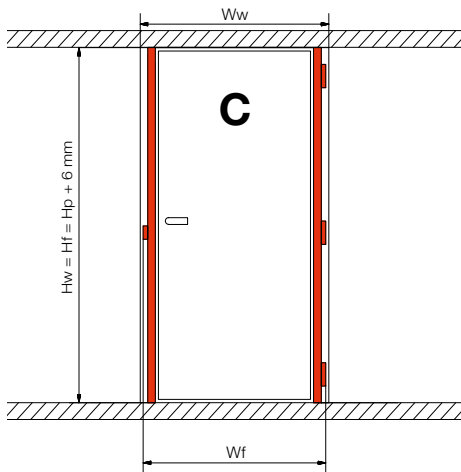

Load capacity <80 kg

$Wf = Wp + 55$

$Ww = Wp + 70$

Load capacity >80 kg

$Wf = Wp + 70$

$Ww = Wp + 85$

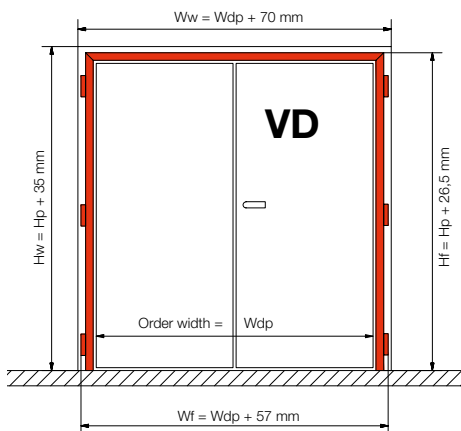

Load capacity <80 kg

$Wf = Wp + 55$

$Ww = Wp + 70$

Load capacity >80 kg

$Wf = Wp + 70$

$Ww = Wp + 85$

System for doors with upper rail

Milling doors

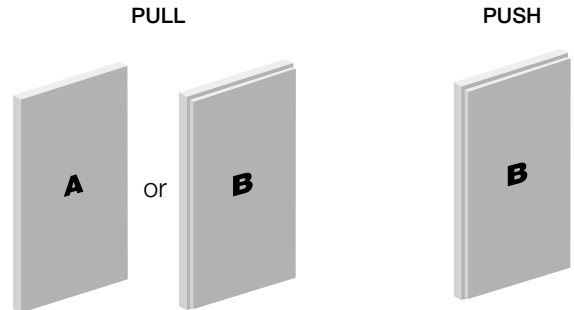

For more information see milling plans

System for ceiling high doors without upper rail

Milling doors

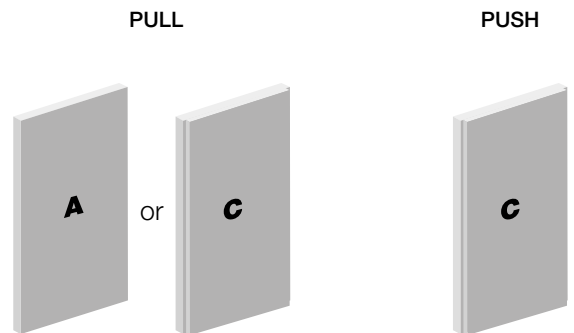

For more information see milling plans

System for double doors

Milling doors

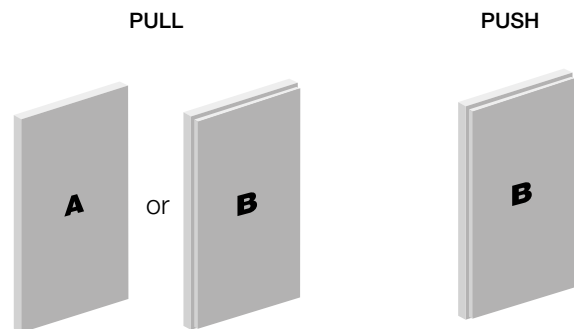

For more information see milling plans

**Hp** = Height doorpanel (max 3500mm)  
**Wp** = Width doorpanel

**Hf** = Height doorframe  
**Wf** = Width doorframe

**Hw** = Opening height wall  
**Ww** = Opening width wall

# X1/X2 - FRAME TYPES

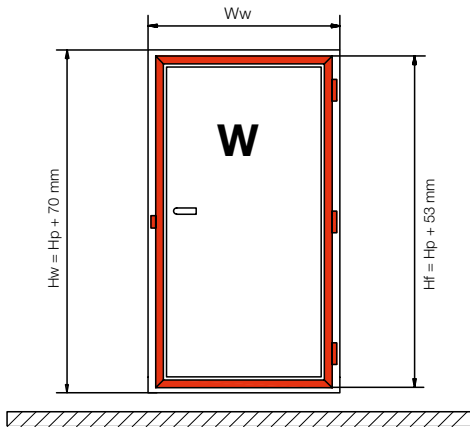

Load capacity <80 kg

$W_f = W_p + 55$

$W_w = W_p + 70$

Load capacity >80 kg

$W_f = W_p + 70$

$W_w = W_p + 85$

System for riser doors

Milling doors

PULL



PUSH



For more information see milling plans

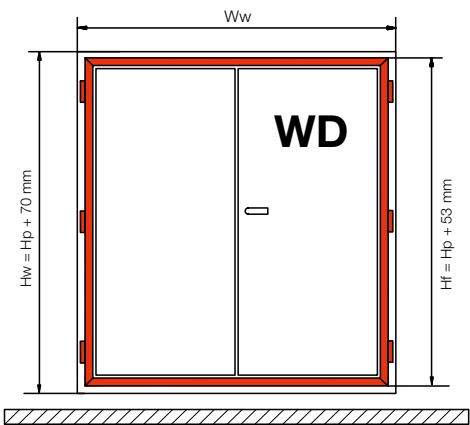

Load capacity <80 kg

$W_f = W_p + 55$

$W_w = W_p + 70$

Load capacity >80 kg

$W_f = W_p + 70$

$W_w = W_p + 85$

System for double riser doors

Milling doors

PULL



PUSH



For more information see milling plans

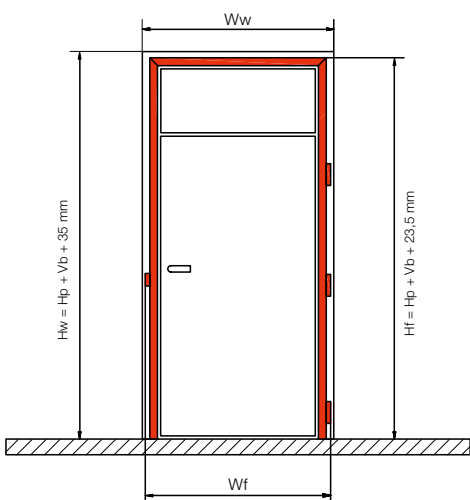

Load capacity <80 kg

$W_f = W_p + 55$

$W_w = W_p + 70$

Load capacity >80 kg

$W_f = W_p + 70$

$W_w = W_p + 85$

System for doors with upperlight

Milling doors

PULL

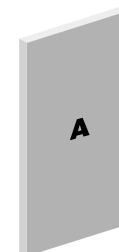

PUSH



For more information see milling plans

**Hp** = Height doorpanel (max 3500mm)

**Wp** = Width doorpanel

**Vb** = Upper ventilation gap

**Hf** = Height doorframe

**Wf** = Width doorframe

**Hw** = Opening height wall

**Ww** = Opening width wall



# X2 - WALL COVERING POSSIBILITIES



	STANDARD FRAME	SPECIAL FRAME
<b>PULL</b>	●	
<b>PUSH</b>	●	
<b>PULL</b>	●	
<b>PUSH</b>	●	
<b>PULL</b>		● max 6mm
<b>PUSH</b>	●	
<b>PULL</b>		● max 6mm
<b>PUSH</b>	●	
<b>PULL</b>		● max 6mm
<b>PUSH</b>	●	
<b>PULL</b>		● max 6mm
<b>PUSH</b>	●	

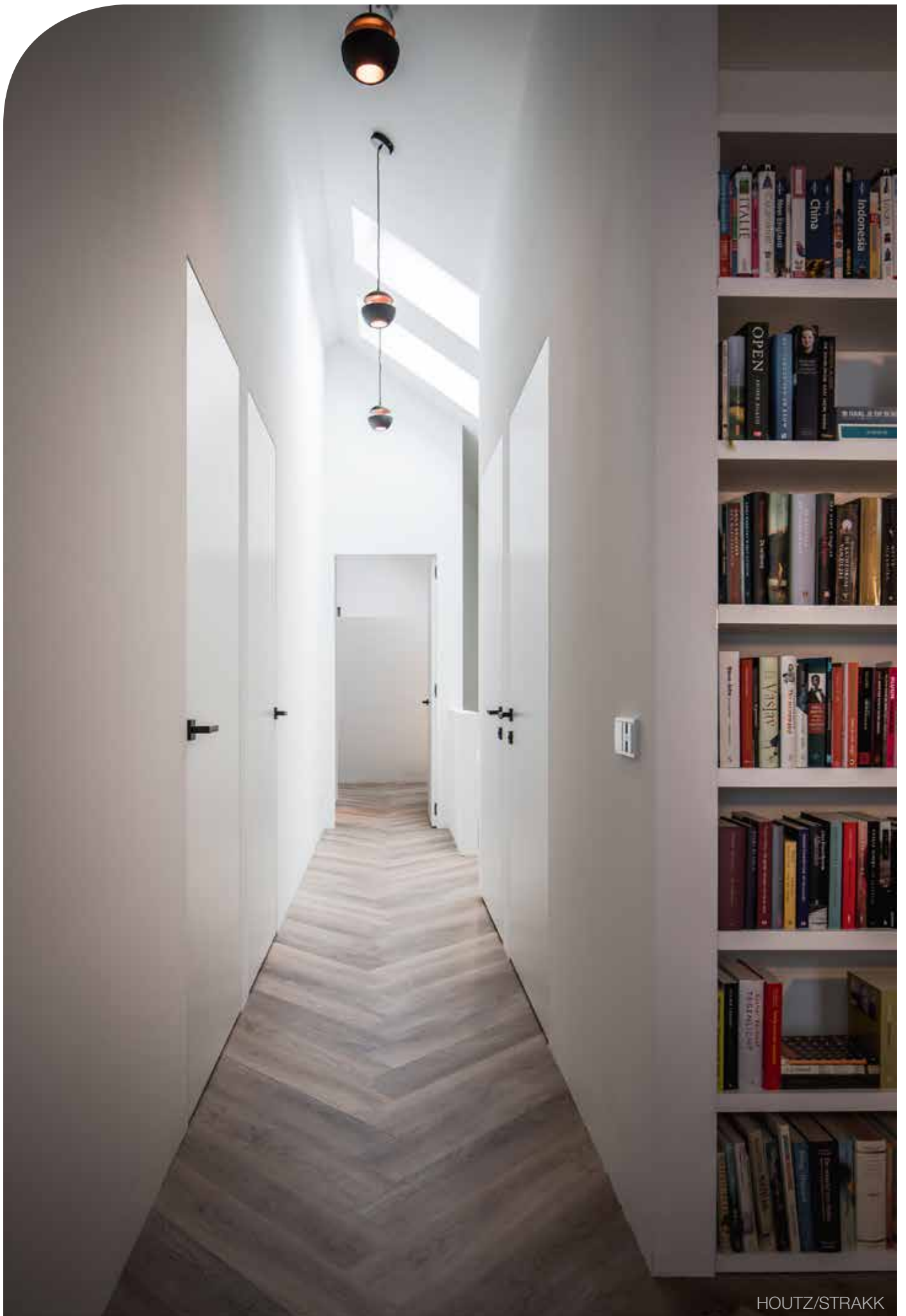

HOUTZ/STRAKK

# X1/X2 - VENTILATION GAPS + ORDER EXAMPLE

## STANDARD

### STOCK ITEMS

#### STANDARD WIDTH

630 680  
710 726 730 780  
810 818 826 830 880  
910 930 980  
1030

#### STANDARD HEIGHT

2015 2040  
2115  
2315

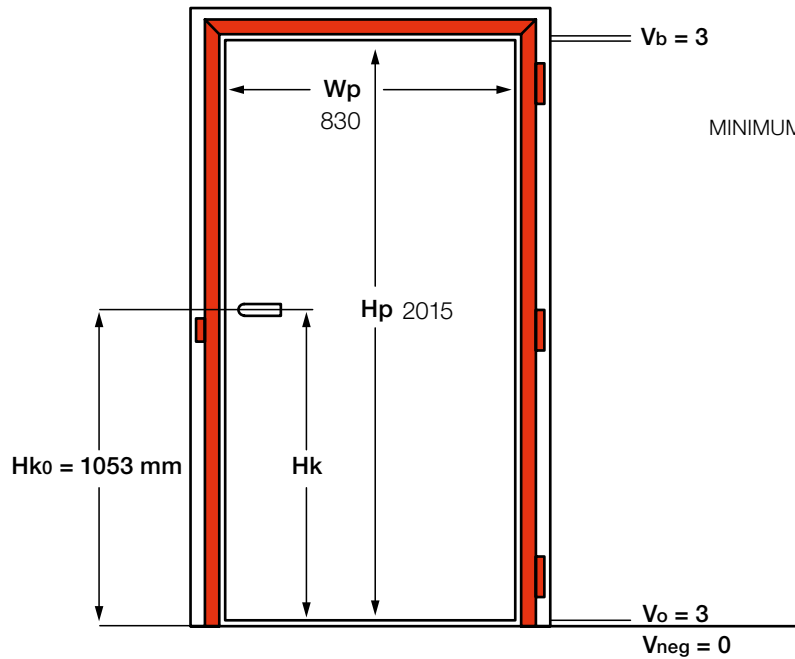

## POSSIBLE ORDER CONFIGURATION

#### MINIMUM CONSTRUCTION OPENING (order example)

2345

#### FRAME DIMENSION (order example)

2245 + 40 ( $V_{neg}$ )

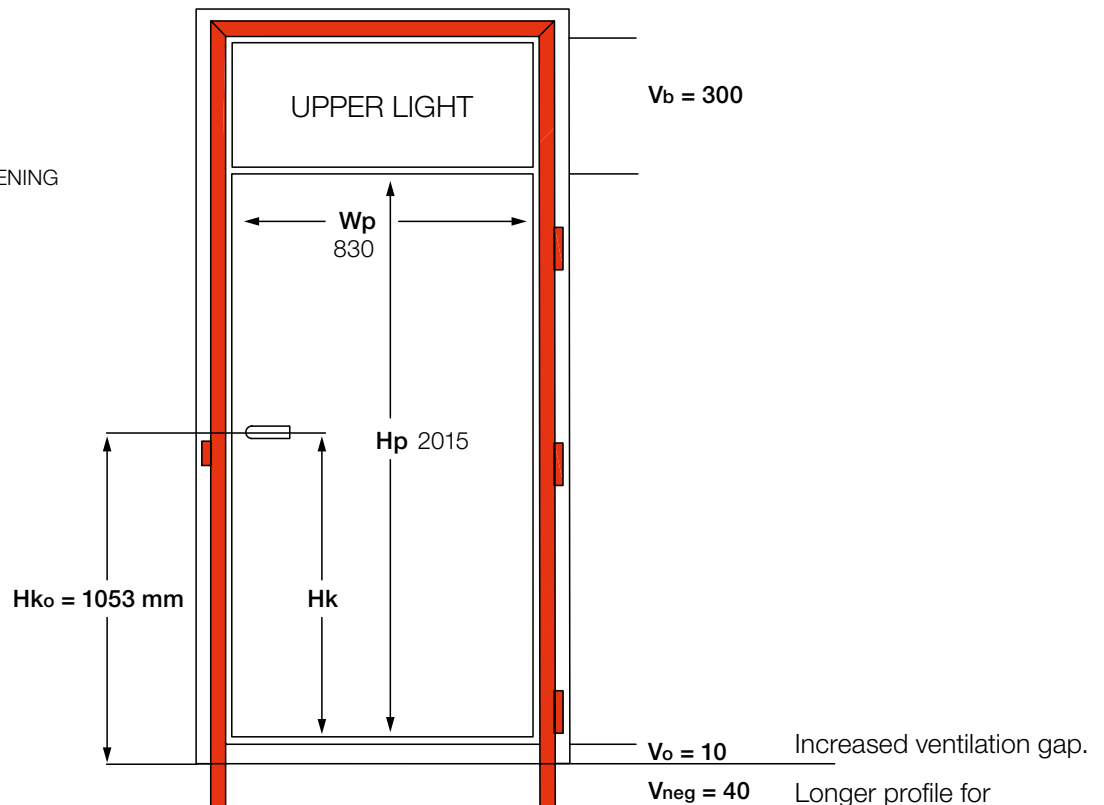

**H<sub>k0</sub>** = Height floor - height handle

**H<sub>k</sub>** = Height handle on door

# X1/X2 - STANDARD HINGES



STANDARD HINGE FOR OUR STOCK FRAMES

## A24

**Load capacity**  
60 kg per 3 hinges  
80 kg per 4 hinges

- Reversible left-right
- Elegant finish due to its invisible attachment
- Slim elegant shape: width of only 24mm
- Opening angle of 180°
- Easy installation (by one person)
- Independent 3D – adjustment  
(side +- 1 mm, height +- 2 mm, pressure +- 1 mm)
- 110 x 24 x 27 mm

ORDER CODE	DESCRIPTION
XA-A24.*	Hinges A24 for Xinnix profile

\* 0= white 1= alu F1 2= black



DIFFERENTS SYSTEMS	X1	X240	X245	X250	X40	X45
POSSIBLE COMBINATIONS	•	•	•	•	•	•

### CLASSIFICATION KEY

2	7	3	1	1	*	0	10
---	---	---	---	---	---	---	----

\*depending on the finish



## TECTUS TE340 3D

**Load capacity**  
80 kg per 2 hinges

- Reversible left and right
- Opening angle of 180°
- Independent 3D – adjustment  
(side +- 3 mm, height +-3 mm, pressure +- 1 mm)
- 160 x 28 x 33.5 mm
- White and Black lacquered hinges are standard delivered in the white and black frames (from spring 2019)
- F1 version available
- Other colours on request

ORDER CODE	DESCRIPTION
XA-TE340.*	Hinges Tectus 340 3D

\* W= white F1= alu F1 B= black



DIFFERENTS SYSTEMS	X1	X240	X245	X250	X40	X45
POSSIBLE COMBINATIONS	•	•	•	•	-	-

### CLASSIFICATION KEY

3	7	4	1	1	*	6	0	11	6
---	---	---	---	---	---	---	---	----	---

\*depending on the finish



# X1/X2 - STANDARD HINGES

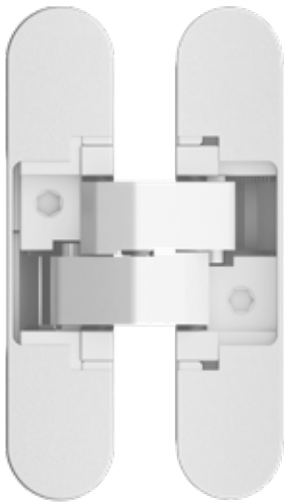

**Load capacity**  
60 kg per 3 hinges  
80 kg per 4 hinges

## X4030

- Reversible left-right
- Elegant finish due to its invisible attachment
- Slim elegant shape: width of only 24mm
- Opening angle of 180°
- Easy installation (by one person)
- Independent 3D – adjustment  
(side +- 1 mm, height +- 2 mm, pressure +- 1 mm)
- 110 x 24 x 27 mm

ORDER CODE	DESCRIPTION
X4030.*	Hinges X4030

\* W= white G= grey B= black



DIFFERENTS SYSTEMS	X1	X240	X245	X250	X40	X45
POSSIBLE COMBINATIONS	•	•	•	•	•	•

### CLASSIFICATION KEY

2	7	3	1	4	0	0	11
---	---	---	---	---	---	---	----

\*depending on the finish

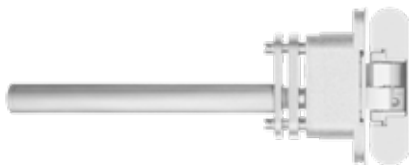

## X4030-SC

**Closing capacity**  
45 kg

- Self-closing hinge with adjustable integrated softclose
- Ideal for ceiling high doors without upper rail
- Reversible left and right
- Easy installation (by one person)
- Independent 3D – adjustment  
(side +- 1 mm, height +- 2 mm, pressure +- 1 mm)
- White and black lacquered hinges are standard delivered in the white and black frames

ORDER CODE	DESCRIPTION
X4030-ARM-SC.*	Selfclosing hinge X4030

\* W= white G= grey B= black

DIFFERENTS SYSTEMS	X1	X240	X245	X250	X40	X45
POSSIBLE COMBINATIONS	•	•	•	•	•	•

# X1/X2 - STANDARD HINGES



## TECTUS TE540 3D

**Load capacity**  
120 kg per 2 hinges

- Reversible left and right
- Opening angle of 180°
- Independent 3D – adjustment  
(side +- 3 mm, height +-3 mm, pressure +- 1 mm)
- 200 x 32 x 36.5 mm

ORDER CODE	DESCRIPTION
XA-TE540F1	Hinges Tectus 540 3D alu F1



DIFFERENTS SYSTEMS	X1	X240	X245	X250	X40	X45
POSSIBLE COMBINATIONS	•	•	•	•	-	-

### CLASSIFICATION KEY

4	7	6	1	1	*6	1	13
---	---	---	---	---	----	---	----

\*depending on the finish



## A31

**Load capacity**  
120 kg per 3 hinges  
140 kg per 4 hinges

- Reversible left-right
- Elegant finish due to its invisible attachment
- Opening angle of 180°
- Independent 3D – adjustment  
(side +- 1.5 mm, height +-3 mm, pressure +- 1 mm)
- 180 x 31 x 35,5 mm

ORDER CODE	DESCRIPTION
XA-A31.0	Hinges A31 alu F1



DIFFERENTS SYSTEMS	X1	X240	X245	X250	X40	X45
POSSIBLE COMBINATIONS	-	-	•	•	-	-

### CLASSIFICATION KEY

4	7	6	1	1	*	6	13
---	---	---	---	---	---	---	----

\*depending on the finish





# X1/X2 - HINGES FOR SPECIAL WALLCOVERINGS



## A30/A303

### Load capacity

A30 = 60 kg per 3 hinges

A303 = 80 kg per 3 hinges

- Reversible left-right
- Elegant finish due to its invisible attachment
- Slim elegant shape: width of only 30mm
- Opening angle of 180°
- Independent 3D – adjustment  
(side +- 1 mm, height +-2 mm, pressure +- 1 mm)
- 120 x 30 x 30 mm
- Wall cladding of 6 mm for flush pull open version

ORDER CODE	DESCRIPTION
XA-A30.0	Hinge A30 white, for Xinnix frame
XA-A303.0	Hinge A303 white, for Xinnix frame

DIFFERENTS SYSTEMS	X1	X240	X245	X250	X40	X45
POSSIBLE COMBINATIONS	-	-	•	•	-	-

### CLASSIFICATION KEY

2	7	3	1	1	*	0	10
---	---	---	---	---	---	---	----

\*depending on the finish



## TECTUS TE540 A8 3D

### Load capacity

100 kg per 2 hinges

- Reversible left-right
- Elegant finish due to its invisible attachment
- Slim elegant shape: width of only 32mm
- Opening angle of 180°
- Independent 3D – adjustment  
(side +- 3 mm, height +-3 mm, pressure +- 1 mm)
- 200 x 32/37 x 44 mm
- Wall cladding of 6 mm for flush pull open version

ORDER CODE	DESCRIPTION
XA-TE540.A8.F1	Hinge TE540 A8 3D for Xinnix frames X250



DIFFERENTS SYSTEMS	X1	X240	X245	X250	X40	X45
POSSIBLE COMBINATIONS	-	-	-	•	-	-

### CLASSIFICATION KEY

4	7	5	1	1	*	1	12
---	---	---	---	---	---	---	----

\*depending on the finish

# X1/X2 - MAGNETIC DOOR LOCKS



## XINNIX DIN LOCK - LATCH VERSION

- Available in 3 versions with different locking possibilities:
  - Key hole 8x72 mm
  - WC lock 8x8x78 mm
  - Europrofile cylinder 8x72 mm
- 8 mm square spindle
- Silent closing
- Maintenance free
- Flush, high-quality appearance
- Low wear since the latch no longer strikes the frame
- Front plate available in white lacquered, black lacquered and stainless steel 235 x 20 mm

ORDER CODE		DESCRIPTION
XA-R15*.55XINBB.TH	🔑	Xinnix R15 DIN lock E=55 BB
XA-R17*.55XINWC.TH	🔑	Xinnix R17 DIN lock E=55 WC
XA-R19*.55XINPZ.TH	🔑	Xinnix R19 DIN lock E=55 PZ

\* W= white I= alu B= black

ORDER CODE		DESCRIPTION
XA-I97.*		Xinnix counterstrike

\* W= white I= alu B= black



## XINNIX DIN LOCK - LATCH AND BOLT VERSION

- Available in 3 versions with different locking possibilities:
  - Key hole 8x72 mm
  - WC lock 8x8x78 mm
  - Europrofile cylinder 8x72 mm
- Silent closing
- Maintenance free
- Front plate available in white lacquered, black lacquered and stainless steel 235 x 20 mm
- Tested according to UNI EN 12209

ORDER CODE		DESCRIPTION
XA-R35*.55XINBB.TH	🔑	Xinnix R35 DIN lock E=55 BB
XA-R37*.55XINWC.TH	🔑	Xinnix R37 DIN lock E=55 WC
XA-R59*.55XINPZ.TH	🔑	Xinnix R59 DIN lock E=55 PZ

\* W= white I= alu B= black

ORDER CODE		DESCRIPTION
XA-I97.*		Xinnix counterstrike

\* W= white I= alu B= black

# X1/X2 - MAGNETIC DOOR LOCKS



## XINNIX LOCK- REVERSIBLE VERSION

- Available in 3 versions with different locking possibilities:
  - Key hole 8x72 mm
  - WC lock 8x8x78 mm
  - Europrofile cylinder 8x72 mm
- 8 mm square spindle
- Flush, high-quality appearance
- Low wear since the latch no longer strikes the frame
- Finish mat chromed
- Silent closing
- Maintenance free
- Front plate available in white lacquered, black lacquered and stainless steel  
190 x 22 mm

ORDER CODE	DESCRIPTION
XA-D70BB.CS	B SMART - Magnetic lock - 8 x 90 mm E=50
XA-D73WC.CS	B SMART - Magnetic lock - 8 x 8 x 95 mm E=50
XA-D78PZ.CS	B SMART - Magnetic lock - 8 x 85 mm E=50

! For milling plans see website

ORDER CODE	DESCRIPTION
XA-I97.*	Xinnix counterstrike

\* W= white I= alu B= black

# X1/X2 - MAGNETIC DOOR LOCKS

## KFV LOCK - LATCH VERSION

- 8 mm square spindle
- Escutcheon holes/ preparation
- Silent closing
- Flush, high-quality appearance
- Low wear since the latch no longer strikes the frame
- Maintenance-free since the latch bevel does not need to be lubricated
- Stainless steel front plate 235 x 20 mm

ORDER CODE	DESCRIPTION
XA-KFV116F	🔑 Magnetic lock KFV 116 F - Inox - 20 x 235 mm E=55



## KFV LOCK- LATCH AND BOLT VERSION

- Available in 3 versions
- Key hole
- WC-lock
- Cylinder-lock

ORDER CODE	DESCRIPTION
XA-KFV116BB	🔑 Magnetic lock KFV 116 Key Standard - Inox 8X72 E=55
XA-KFV116WC	🔑 Magnetic lock KVF 116 WC - Inox 8X8X78 E=55
XA-KFV116PZ	🔑 Magnetic lock KVF 116 Cylinder - Inox 8X72 E=55





## NO-HA MINI

- Smooth opening and closing of the door
- Design: the panel of the door is completely smooth
- Safe for children
- Reliability: no moving elements
- Maintenance free
- 190 x 22 mm
- Front plate available in mat chrome

ORDER CODE	DESCRIPTION
XA-937 <span style="color: red;">❶</span>	No-Ha Mini WC Magnetic lock - Satin Chrome - 6 mm <span style="float: right;">☒</span>
XA-938 <span style="color: red;">❷</span>	No-Ha Mini Magnetic lock - Satin Chrome

XA-998NH.CS	Magnetic strike small for No-Ha
-------------	---------------------------------

XA-NH003I	Cover plate - 85 x 43 x 3 mm - INOX
XA-NH004M	Cover plate - 85 x 43 x 4 mm - MDF
XA-NH006M	Cover plate - 85 x 43 x 6 mm - MDF
XA-NH016M	Cover plate - 85 x 43 x 16 mm - MDF



## NO-HA SLIDE

- Silent and smooth opening and closing of the door
- Design: the panel of the door is completely smooth
- Safe for children
- Reliability: no moving elements
- Maintenance free

! For swing doors in combination with XA-NZ p.26



ORDER CODE	DESCRIPTION
XA-NHNS105	No-Ha handle for sliding door >27 mm - 1 sided
XA-NHNS200	No-Ha handle for sliding door 38-42 mm - 2 sided
XA-NHNS205	No-Ha handle for sliding door 43-47 mm - 2 sided
XA-NHNS210	No-Ha handle for sliding door 48-52 mm - 2 sided
XA-NHNS250	No-Ha handle for cupboard door >19 mm - 1 sided

## NO-HA LOCCO & CARTEL

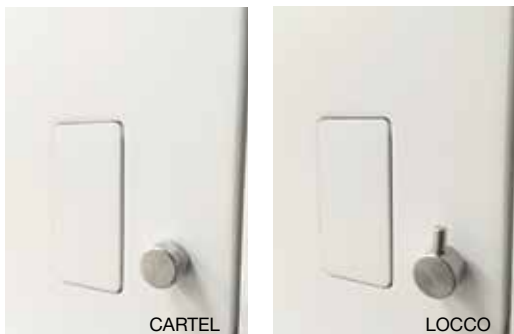

- Cartel and Locco are used to lock the toilet door on the inner side without indicating anything on the outside part of the door
- Minimalist appearance
- Stainless steel brushed finish

ORDER CODE	DESCRIPTION
XA-NHCARTEL	No-Ha Cartel WC set simple face
XA-NHLOCCO	No-Ha Locco WC set simple face

## NZ<sup>©</sup>



- Magnetic roller lock
- Can be combined with pull handle, knob and No-Ha Slide
- Functions for swing and pivoting doors

ORDER CODE	DESCRIPTION
XA-NZ.G	Magnetic roller lock NZ - Grey
XA-NZ.W	Magnetic roller lock NZ - White
XA-NZ.B	Magnetic roller lock NZ - Black

## NZ<sup>©</sup>



- Magnetic roller lock with frontal plate to cover the milling of a lock in the door
- Front plate available in stainless steel
- Set of 1 NZ + 1 long frontplate
- Can be combined with pull handle, knob and No-Ha Slide
- Functions for swing and pivoting doors

ORDER CODE	DESCRIPTION
1 XA-NZ190.G	Magnetic roller lock NZ - Grey - 190 x 22 mm
2 XA-NZ290.G	Magnetic roller lock NZ - Grey - 290 x 22 mm
3 XA-NZ190.NH	Magnetic roller lock NZ - Grey - 190 x 22 mm- To change magnetic No-Ha lock

## WINKHAUS MULTIPOINT

- Reliable 3- or 5-point security door locking system with hooks
- Stable hooks made from chrome-plated steel

ORDER CODE	LOCKING	OPENING
XA-SEC-LOCK 1	Manual	Manual
XA-SEC-LOCK 2	Automatic	Manual
XA-SEC-LOCK 3	Automatic	Electrical

! Milling plan on our website

## ELECTRICAL COUNTERSTRIKE

- Compatible with magnetic locks
- Suitable for fire rated doors
- Adjustable by 3 mm
- Plug-in connection

1. Fail locked solution:

ORDER CODE	DESCRIPTION	VOLTAGE
XA-EL118-XIN	Electrical counter strike + BB	10-24 V
XA-EL118-DIN	Electrical counter strike + DIN	10-24 V

2. Fail unlocked solution:

ORDER CODE	DESCRIPTION	VOLTAGE
XA-EL138-XIN	Electrical counter strike + BB	10-24 V
XA-EL138-DIN	Electrical counter strike + DIN	10-24 V

Other counterstrikes available on request.

! Milling plan on our website



XIN



DIN

# X1/X2 - INTEGRATED DOOR CLOSERS



## ACTIVE STOP

The Active Stop is a Soft opening and Soft closing with opening angle limitation. It can be used in all types of XINNIX X1 and X2 doorsystems. With a maximum door weight of 40 kg.

ORDER CODE	DESCRIPTION
XA-AS001	GEZE Active Stop: soft open + soft close (max 40kg/door)



# X1/X2 - INTEGRATED DOOR CLOSERS

## SINGLE DOORS

DOOR CLOSER TYPES	X1	X240		X245		X250	
	PULL	PULL	PUSH	PULL	PUSH	PULL	PUSH
Boxer 2-4 (door width: <1100 mm) MAX 130 KG	•	•	•	•	•	•	•
Boxer 3-6 (door width: <1400 mm) MAX 180 KG	-	-	•	-	•	•	•



ORDER CODE	DESCRIPTION
XA-BOXER 2-4	GEZE Boxer integrated universal door closer L/R EN 2-4
XA-BOXER 3-6	GEZE Boxer integrated universal door closer L/R EN 3-6

DOOR CLOSER TYPES	X240		X245		X250	
	PULL	PUSH	PULL	PUSH	PULL	PUSH
Boxer E with electrical hold-open device	•	•	•	•	•	•
Boxer EFS with electrical free swing function	-	•	-	•	•	•



ORDER CODE	DESCRIPTION
XA-BOXER-E	Integrated door closer with electric hold-open device 80-120°
XA-BOXER-EFS	Integrated door closer with electrical free swing function

# X2 - INTEGRATED AUTOMATIC DOOR CLOSERS

## DOUBLE DOORS



Only compatible with the X250 frame.



ORDER CODE	DESCRIPTION
XA-BOXER-ISM	Integrated door closer EN2-4 with closing selector
XA-BOXER-E-ISM	Integrated door closer en2-4 with electrical hold-open device and closing selector
XA-BOXER-EFS-ISM	Integrated door closer with electrical free swing function and closing selector



# X2 - INTEGRATED AUTOMATIC DOOR CLOSERS

## AUTOMATIC OPENING AND CLOSING

With the ECturn Inside swing door drive, Xinnix and GEZE combine accessibility and safety with optimum door design. Thanks to its small dimensions, the drive can be integrated into the door leaf of internal doors.

The ECturn Inside opens and closes doors “invisibly” without compromising their appearance.

The wide range of special functions such as radio push buttons, mobile radio remote control units or acoustic signals allow the system to be tailored to specific user requirements.

ECturn Inside can be operated in low-energy and automatic modes. In low-energy mode the drive moves the swing door at reduced speed, thus fulfilling the safety level of DIN 18650 and EN 16005.

The door can also be opened manually in the event of a power failure.

**Only compatible with the X250 frame.**



ORDER CODE	DESCRIPTION
XA-ECTURN-AUTO	GEZE EC Turn Automatic

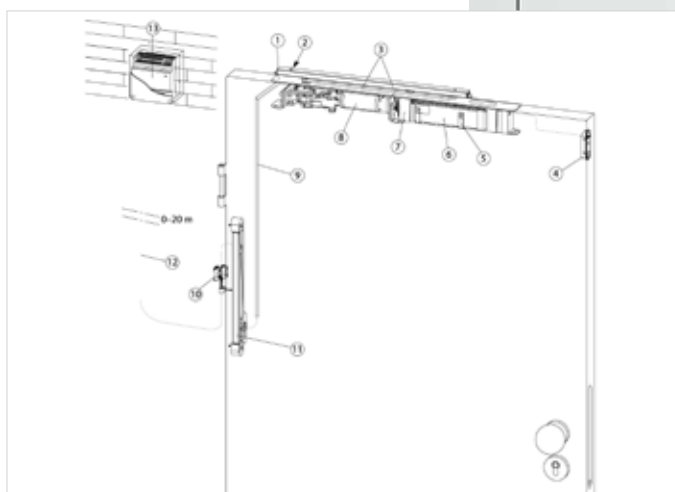

## X2 - FINISHING PROFILE FOR DIFFERENT WALL THICKNESS

Plasterboard 9 mm with integrated aluminium cornerbead for easy finishing of all wall thicknesses.



### POSSIBLE DIMENSIONS

ORDER CODE	DESCRIPTION
XA-FIN2200/120	Plasterboard with corner alu 2200x120x9 mm
XA-FIN2200/120	Plasterboard with corner alu 2200x260x9 mm
XA-FIN2600/120	Plasterboard with corner alu 2600x120x9 mm
XA-FIN3000/120	Plasterboard with corner alu 3000x120x9 mm
XA-FIN3000/260	Plasterboard with corner alu 3000x120x9 mm

### PACKAGINGS IN DOOR SETS

ORDER CODE	DESCRIPTION
XA-KFIN2088/140/KE1	Set for 1 door : 2 x 2088x140x9 mm + 1 x 1044x140x9 mm
XA-KFIN2200/120/KE1	Set for 1 door : 2 x 2200x120x9 mm + 1 x 1100x120x9 mm
XA-KFIN2200/120/KE1	Set for 2 door : 4 x 2200x120x9 mm + 2 x 1100x120x9 mm
XA-KFIN2600/120/KE1	Set for 1 door : 2 x 2600x120x9 mm + 1 x 1100x260x9 mm
XA-KFIN2600/120/KE2	Set for 2 door : 4 x 2600x120x9 mm + 2 x 1100x120x9 mm



# X1/X2 - PUSH & GO

---

Push & Go – We are glad to introduce you our new PUSH & GO system for double doors.

Technical improvement and smart solutions: that's what Xinnix is all about.

Push&Go is a new magnetic system for the fast and easy opening of the fixed part of your double door.

1 push on the button and your door leaf is free.

The locking is as easy as the opening of the door: when closing the door, the magnet returns in the counterstrike (in the upper rail) and your door stays locked.

→ Perfect for high - double doors!

! Very nice elegant finish for every door thickness.

ORDER CODE	DESCRIPTION
XA-PG4100.W	Magnetic Double door opening system - white
XA-PG4100.CS	Magnetic Double door opening system - mat chrome



With just one push the fixed wing opens and you create a complete free passage. The magnetic closure ensures quick, effortless locking.

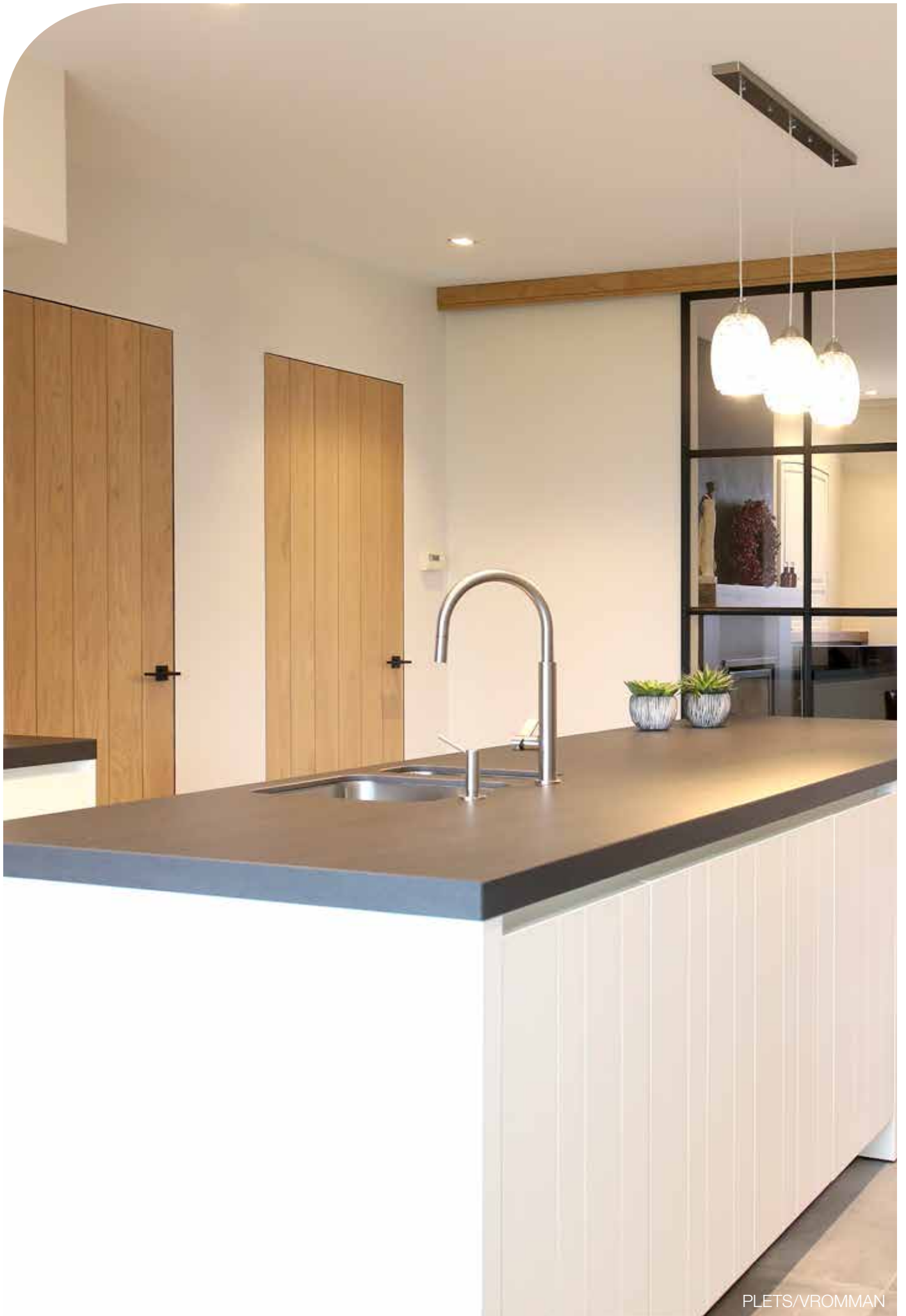

PLETS/VROMMAN

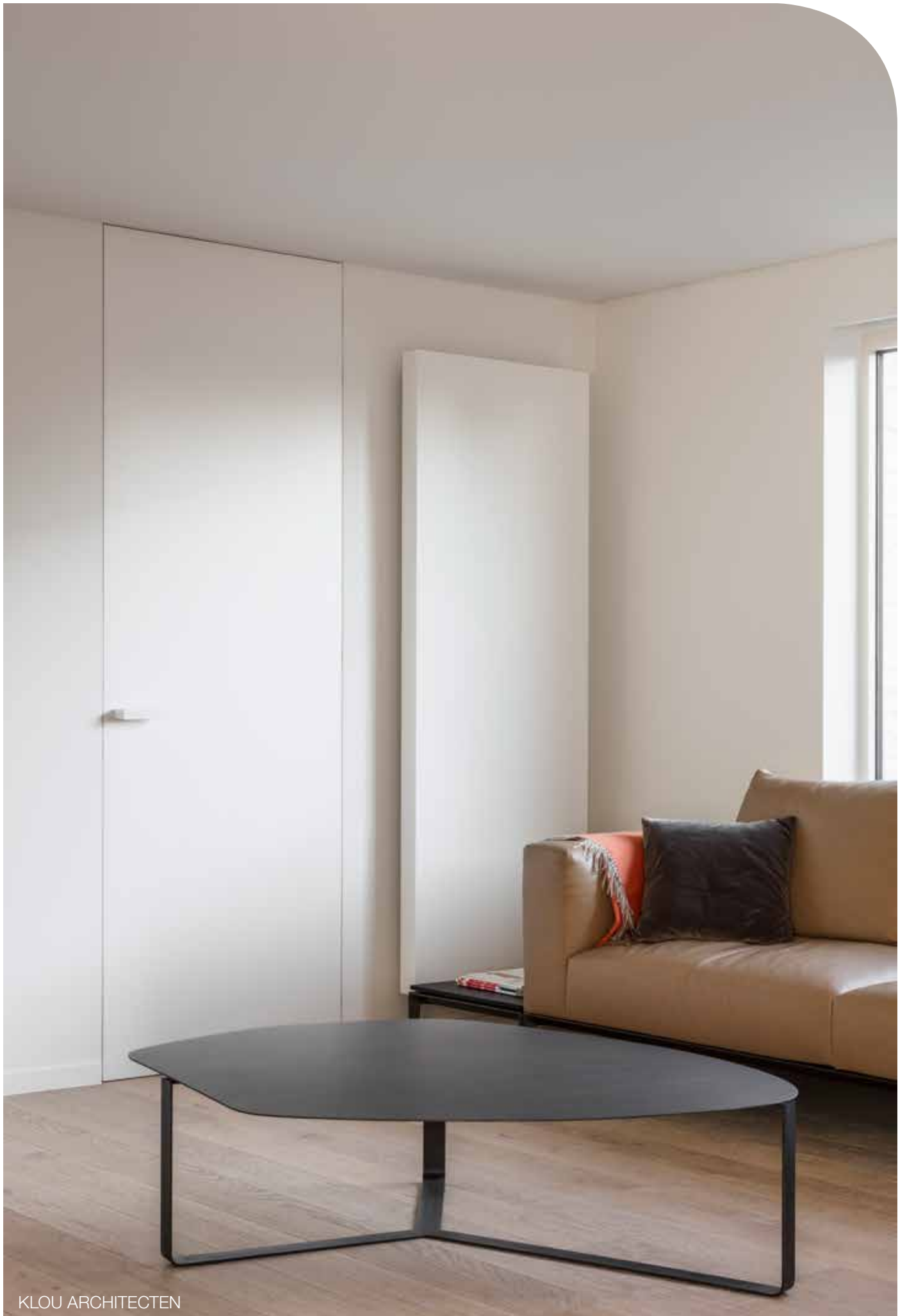

# X1/X2 - DOOR HANDLES AND ACCESSORIES



XINNIX Serie 001 Handle without rose anodized BLACK

ORDER CODE	DESCRIPTION
XA-A001.B	Door handle without rose - Anodised black

! For more details visit the website



XINNIX Serie 001 Fixed knob anodized BLACK

ORDER CODE	DESCRIPTION
XA-AK001.B	Fixed knob - Anodised black

! For more details visit the website



KEY HOLE ROSES

ORDER CODE	DESCRIPTION
XA-A001BB.B	BB set - Anodised black
XA-A001PZ.B	PZ set - Anodised black

! For more details visit the website



PRIVACY SET

ORDER CODE	DESCRIPTION
XA-A001WC.B	Privacy set - Anodised black

XINNIX Serie 002 Handle anodised BLACK



ORDER CODE	DESCRIPTION
XA-A002.B	Door handle without rose - Anodised black

! For more details visit the website



PRIVACY SET

ORDER CODE	DESCRIPTION
XA-A002WC.B	Privacy set - Anodised black

# X1/X2 - DOOR HANDLES AND ACCESSORIES



XINNIX Serie 001 Handle without rose laquered in WHITE

ORDER CODE	DESCRIPTION
XA-A001.W	Door handle without rose - Laquered white

! For more details visit the website



XINNIX Serie 001 Fixed knob laquered in WHITE

ORDER CODE	DESCRIPTION
XA-AK001.W	Fixed knob - Laquered white

! For more details visit the website

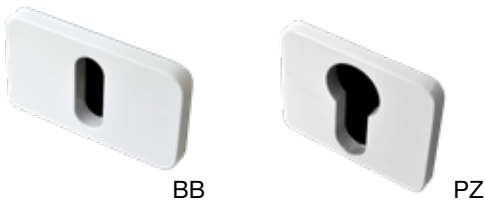

KEY HOLE ROSES

ORDER CODE	DESCRIPTION
XA-A001BB.W	BB set - Laquered white
XA-A001PZ.W	PZ set - Laquered white

! For more details visit the website



PRIVACY SET

ORDER CODE	DESCRIPTION
XA-A001WC.W	Privacy set - Laquered white



XINNIX Serie 002 Handle laquered WHITE

ORDER CODE	DESCRIPTION
XA-A002.W	Door handle without rose - Laquered white

! For more details visit the website



PRIVACY SET

ORDER CODE	DESCRIPTION
XA-A002WC.W	Privacy set - Laquered white

# X1/X2 - DOOR HANDLES AND ACCESSORIES

---

## HORIZONTAL VERSION

---

- 180 x 45 mm



ORDER CODE	DESCRIPTION
XA-H180.NS	Horizontal pull - Mat nickel
XA-H180.W	Horizontal pull - White
XA-H180.B	Horizontal pull - Black

## VERTICAL VERSION

---

- 160 x 25 mm



ORDER CODE	DESCRIPTION
XA-H160.NS	Vertical pull - Mat nickel
XA-H160.W	Vertical pull - White
XA-H160.B	Vertical pull - Black

# X1/X2 - DOOR HANDLES AND ACCESSORIES



- Pair of lever handles in stainless steel AISI 316L
- Lever handle with return spring
- Galvanized steel spindle, 8 mm
- Length 150 x 30 mm

ORDER CODE	DESCRIPTION
XA-RF150	Door handle - Satin stainless steel
XA-RF150.P	Door handle - Bright stainless steel

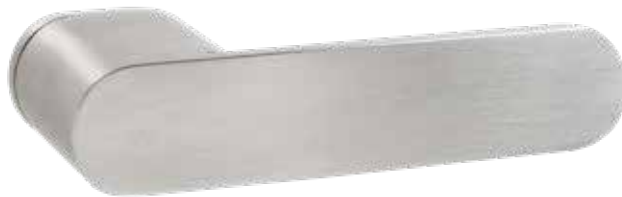

- Pair of lever handles in stainless steel AISI 316L
- Lever handle with return spring
- Galvanized steel spindle, 8 mm
- Length 140 x 30 mm

ORDER CODE	DESCRIPTION
XA-RF140	Door handle - Satin stainless steel



- Pair of lever handles in stainless steel AISI 316L
- Lever handle with concealed rose with return spring
- Galvanized steel spindle, 8 mm
- Length 180 x 30 mm

ORDER CODE	DESCRIPTION
XA-RF180	Door handle ELICA - Satin stainless steel



- Fixed knob in stainless steel AISI 316L
- Length 60 x 30 mm

ORDER CODE	DESCRIPTION
XA-RF150.004.50L	Xinnix handle with knob EU L
XA-RF150.004.50R	Xinnix handle with knob EU R

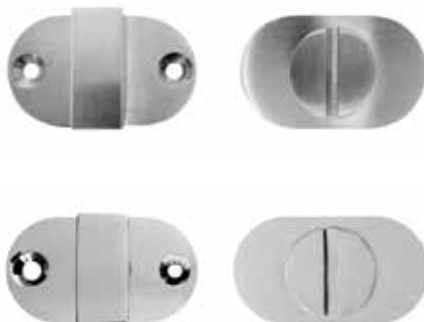

## PRIVACY SET

ORDER CODE	DESCRIPTION
XA-RF.WC	Privacy set RF-Serie - Satin stainless steel

ORDER CODE	DESCRIPTION
XA-RF.WC.P	Privacy set RF-Serie - Satin stainless steel

# X1/X2 - DOOR HANDLES AND ACCESSORIES

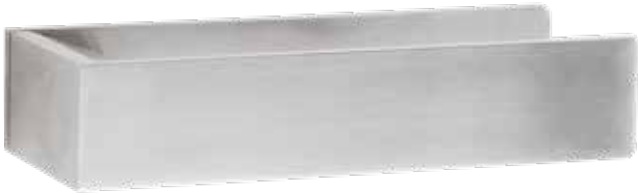

- Pair of lever handles in stainless steel AISI 316L
- Lever handle with return spring
- Galvanized steel spindle, 8 mm
- Length 130 x 30 mm

ORDER CODE	DESCRIPTION
XA-IT2001	Handle in AISI 316L - Satin stainless steel



## PRIVACY SET

ORDER CODE	DESCRIPTION
XA-IT.WC	WC set IT-Serie - Satin stainless steel



## KEY HOLE ROSES

ORDER CODE	DESCRIPTION
XA-IT.BB	BB set IT-Serie - Satin stainless steel
XA-IT.PZ	PZ set IT-Serie - Satin stainless steel

BB

PZ



- Pair of lever handles in stainless steel AISI 316L
- Lever handle with return spring
- Galvanized steel spindle, 8 mm
- Length 130 x 30 mm

ORDER CODE	DESCRIPTION
XA-IT151	Handle in AISI 316L - Satin stainless steel



## PRIVACY SET

ORDER CODE	DESCRIPTION
XA-IT002.WC	Xinnix WC set - Square serie - Satin stainless steel



## KEY HOLE ROSES

ORDER CODE	DESCRIPTION
XA-IT002.BB	Xinnix BB set - Square serie - Satin stainless steel
XA-IT002.PZ	Xinnix PZ set - Square serie - Satin stainless steel

BB

PZ



# X1/X2 - DOOR HANDLES AND ACCESSORIES



- Pair of lever handles in stainless steel AISI 316L
- Lever handle without return spring
- Galvanized steel spindle, 8 mm
- Length 135 x 50 mm

ORDER CODE	DESCRIPTION
XA-2016	Handle in AISI 316L - Satin stainless steel



- Pair of lever handles in stainless steel AISI 316L
- Lever handle with return spring
- Galvanized steel spindle, 8 mm
- Length 135 x 50 mm

ORDER CODE	DESCRIPTION
XA-2016L	L Handle in AISI 316L - Satin stainless steel



## PRIVACY SET

ORDER CODE	DESCRIPTION
XA-2033	Xinnix WC set 4 mm round serie - Satin stainless steel



## KEY HOLE ROSES

ORDER CODE	DESCRIPTION
XA-BB	BB set 4 mm round serie - Satin stainless steel
XA-PZ	PZ set 4 mm round serie - Satin stainless steel



ORDER CODE	DESCRIPTION
XA-004.BB	BB escutcheon oval - Satin stainless steel
XA-004.PZ	PZ escutcheon oval - Satin stainless steel
XA-004.BB.P	BB escutcheon oval - Bright stainless steel
XA-004.PZ.P	PZ escutcheon oval - Bright stainless steel

# XP50<sup>®</sup> - UNIVERSAL INTEGRATED PLINTH

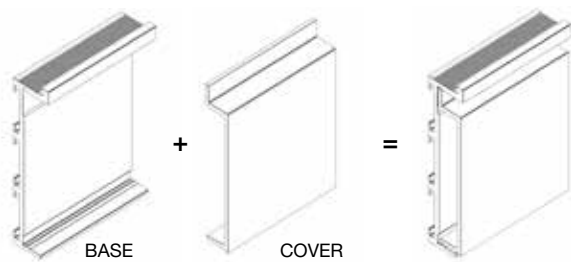

## MINIMALISTIC PLINTH FOR FLUSH INSTALLATION

- Untreated, natural mat anodized or white coated profiles
- Possibility to glue a stainless steel topplate on the cover profile
- All installation and adjustment pieces are available
- Mechanically fixed or glued invisible in the wall construction
- Precious timeless finish
- Minimalistic dimensions: 50 x 13 mm

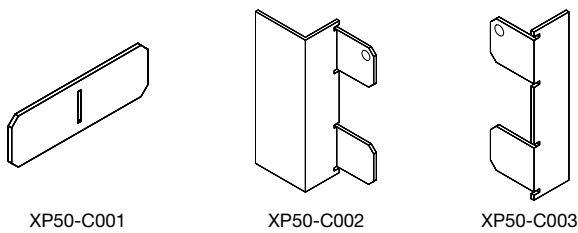

XP50-C001

XP50-C002

XP50-C003



XP50+45

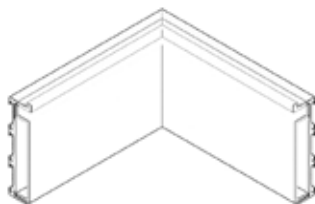

XP50-45

ORDER CODE	DESCRIPTION
XP50-3000.B	Base plinth 3000 mm - Raw
XP50-3000.A	Base plinth 3000 mm - Anodised F1
XP50-3000.W	Base plinth 3000 mm - White primer
XP50-3000.B.COVER	Cover plinth 3000 mm - Raw
XP50-3000.A.COVER	Cover plinth 3000 mm - Anodised F1
XP50-3000.W.COVER	Cover plinth 3000 mm - White primer

XP50-C001	Connection part for 2 lengths
XP50-C002	Junction part for a XINNIX frame
XP50-C003	End piece for a clean stop
XP50-A045	Pre-cut angle XP50 +45° -45°

## ONE BASE FOR DIFFERENT VERSIONS

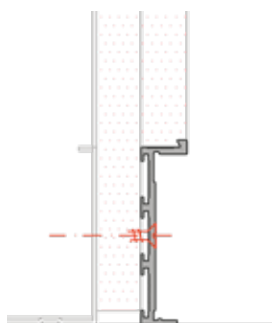

Negative version -9 mm  
- XP50

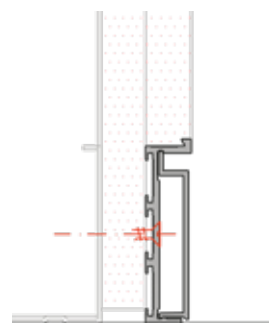

Flush version with cover  
XP50 + XP50-Cover

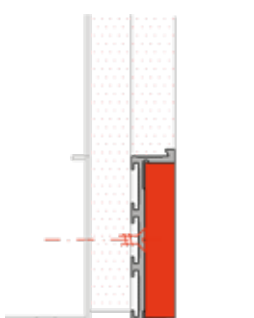

Flush version with HPL  
or stone plinth  
XP50 + plinth (not included)

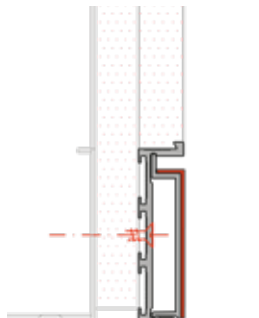

Flush version with cover and  
stainless steel top plate  
XP50 + XP50-Cover + XP50-RVS

# XP50-04 - UNIVERSAL INTEGRATED PLINTH

## MINIMALISTIC PLINTH FOR FLUSH INSTALLATION

- All installation and adjustment pieces are available
- Glued invisible in the wall construction
- Precious timeless finish
- Minimalistic dimensions: 50 x 4 mm

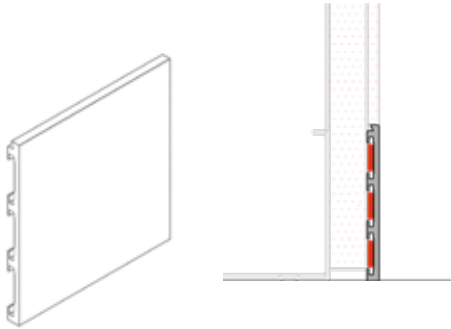

ORDER CODE	DESCRIPTION
XP50-04.3000.W	Base plinth 3000 mm - White primer

## CONNECTION PARTS

### PUSH VERSION

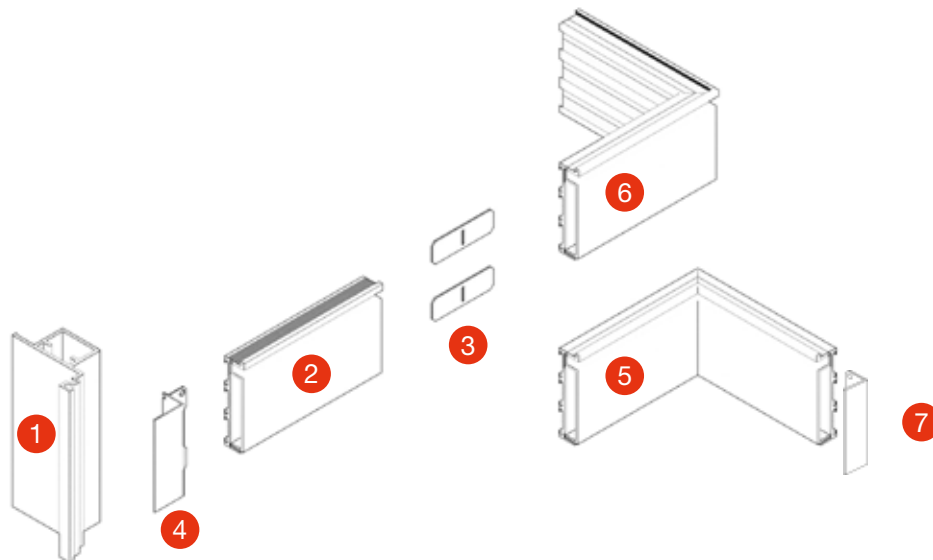

### PULL VERSION

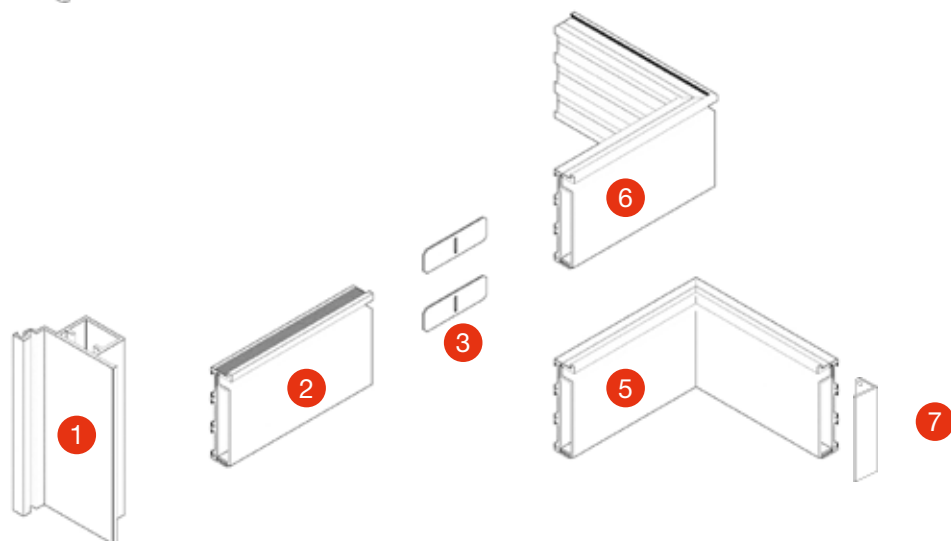

- 1 X2 Profile
- 2 XP50 Plinth XP50-3000
- 3 Connection part XP50-C001
- 4 Junction part XP50-C002
- 5 Inside corner XP50-45
- 6 Outside corner XP50+45
- 7 End piece for a clean stop XP50-C003

# X1 - EXPLODED VIEW - STANDARD/WITH UPPERRAIL

CONTENT BOX - EASY DISTRIBUTION SYSTEM



- 1 Uprights
- 2 Upper rail + distance keeper
- 3 Finishing profile (in option - to be ordered separately)

! For more details visit the website or follow our YOUTUBE channel.

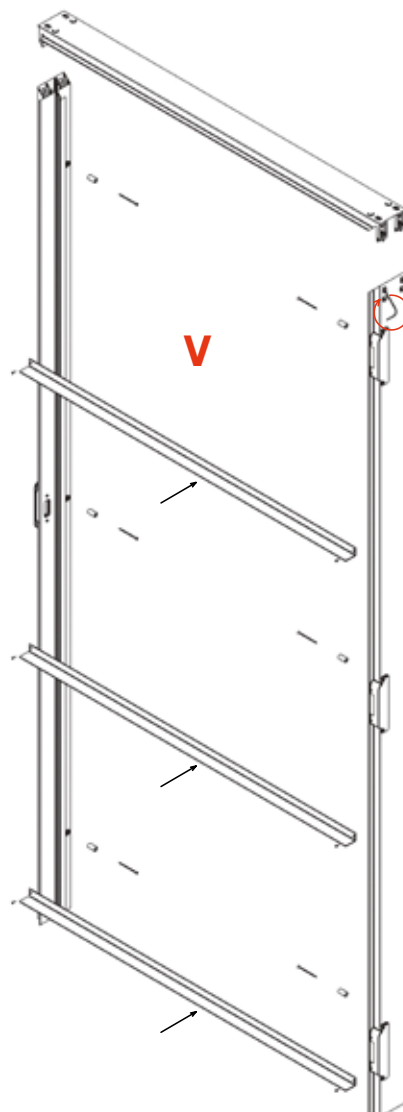

# X1 - EXPLODED VIEW - STANDARD/WITHOUT UPPERRAIL

CONTENT BOX - EASY DISTRIBUTION SYSTEM



- 1 Uprights
- 2 Distance keeper (when door width is mentioned on the order)
- 3 Finishing profile (in option - to be ordered separately)

! For more details visit the website or follow our YOUTUBE channel.

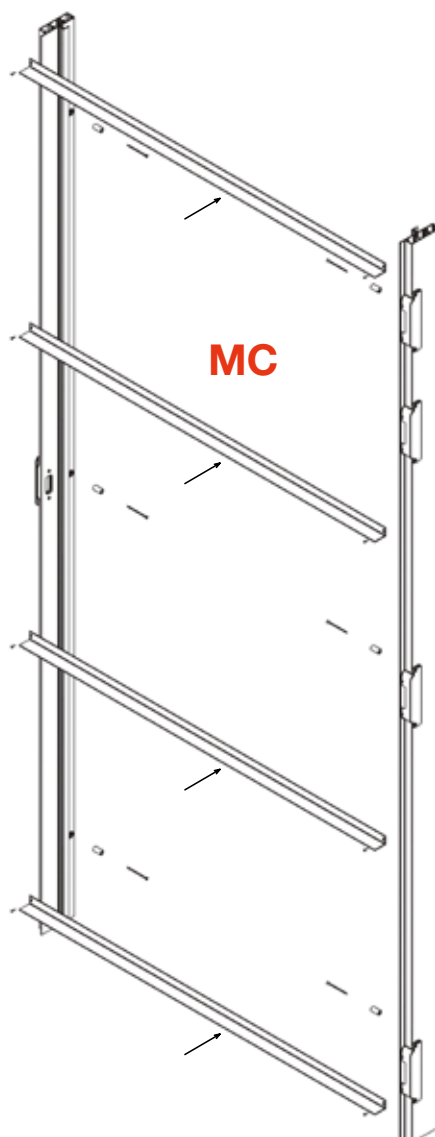
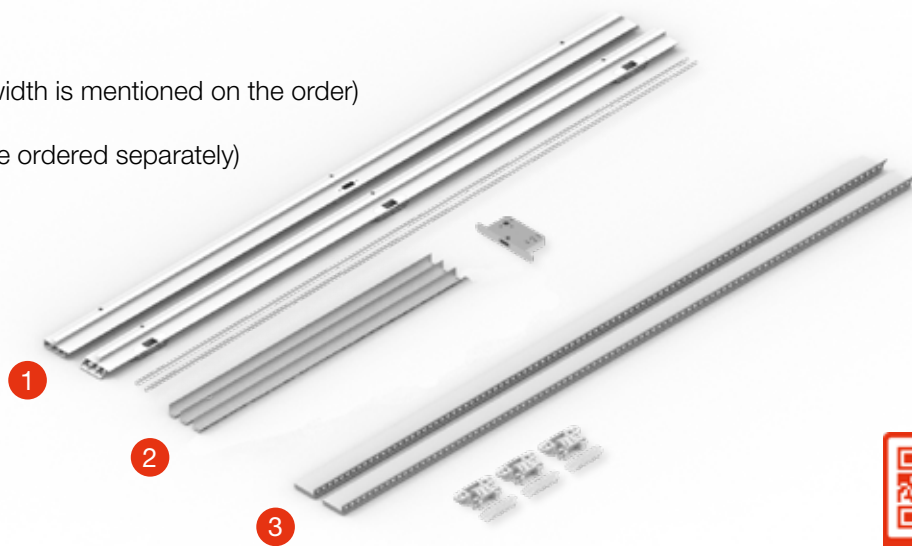

# X2 - EXPLODED VIEW - STANDARD/WITH UPPERRAIL



## CONTENT BOX - EASY DISTRIBUTION SYSTEM

- 1 Uprights + fixing profiles
- 2 Upper rail + distance keeper
- 3 Finishing profile (in option - to be ordered separately)

! For more details visit the website or follow our YOUTUBE channel.

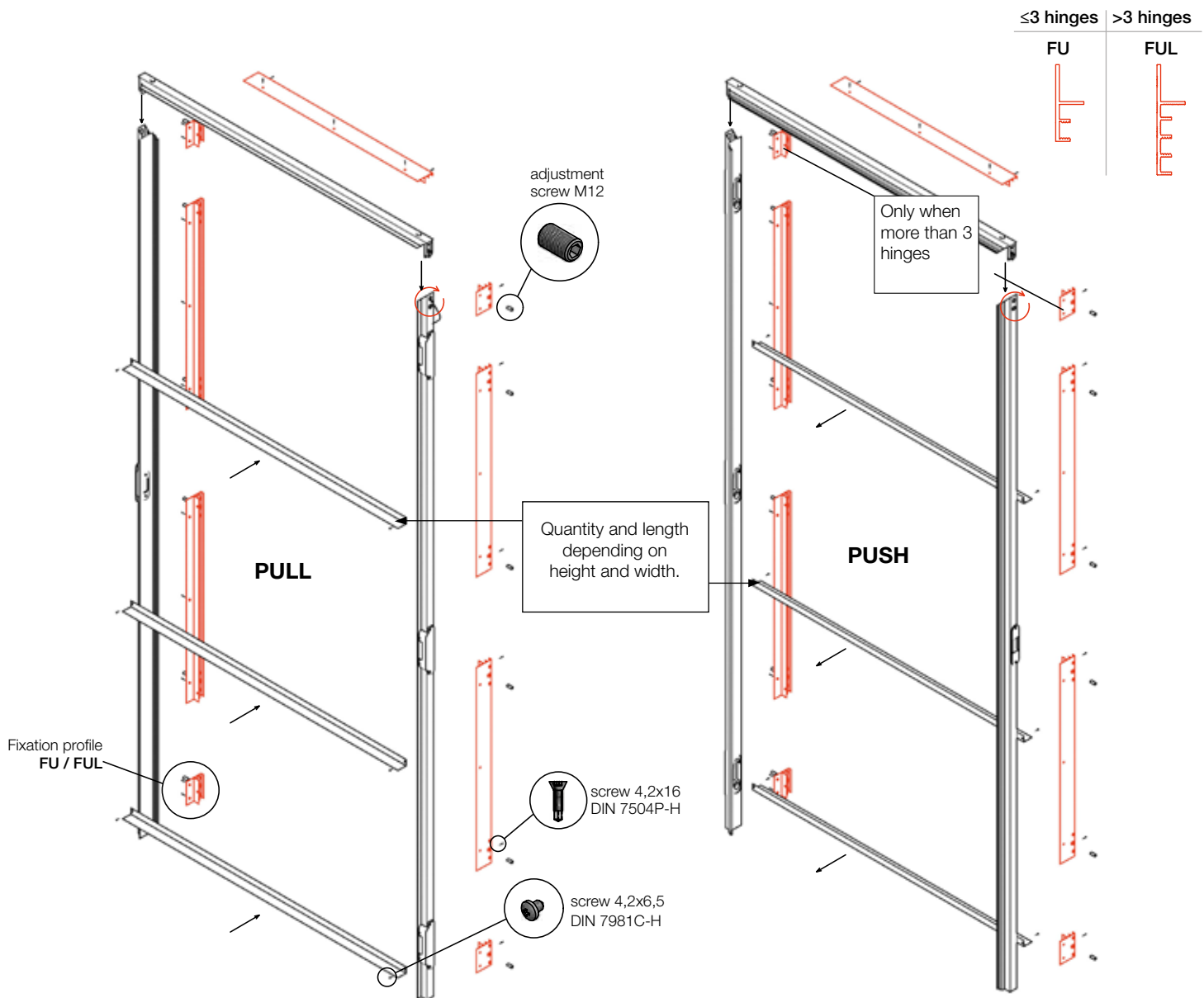

# X2 - EXPLODED VIEW - STANDARD/WITHOUT UPPERRAIL

CONTENT BOX - EASY DISTRIBUTION SYSTEM



- 1 Uprights + fixing profiles
- 2 Distance keeper (when door width is mentioned on the order)
- 3 Finishing profile (in option - to be ordered separately)

! For more details visit the website or follow our YOUTUBE channel.

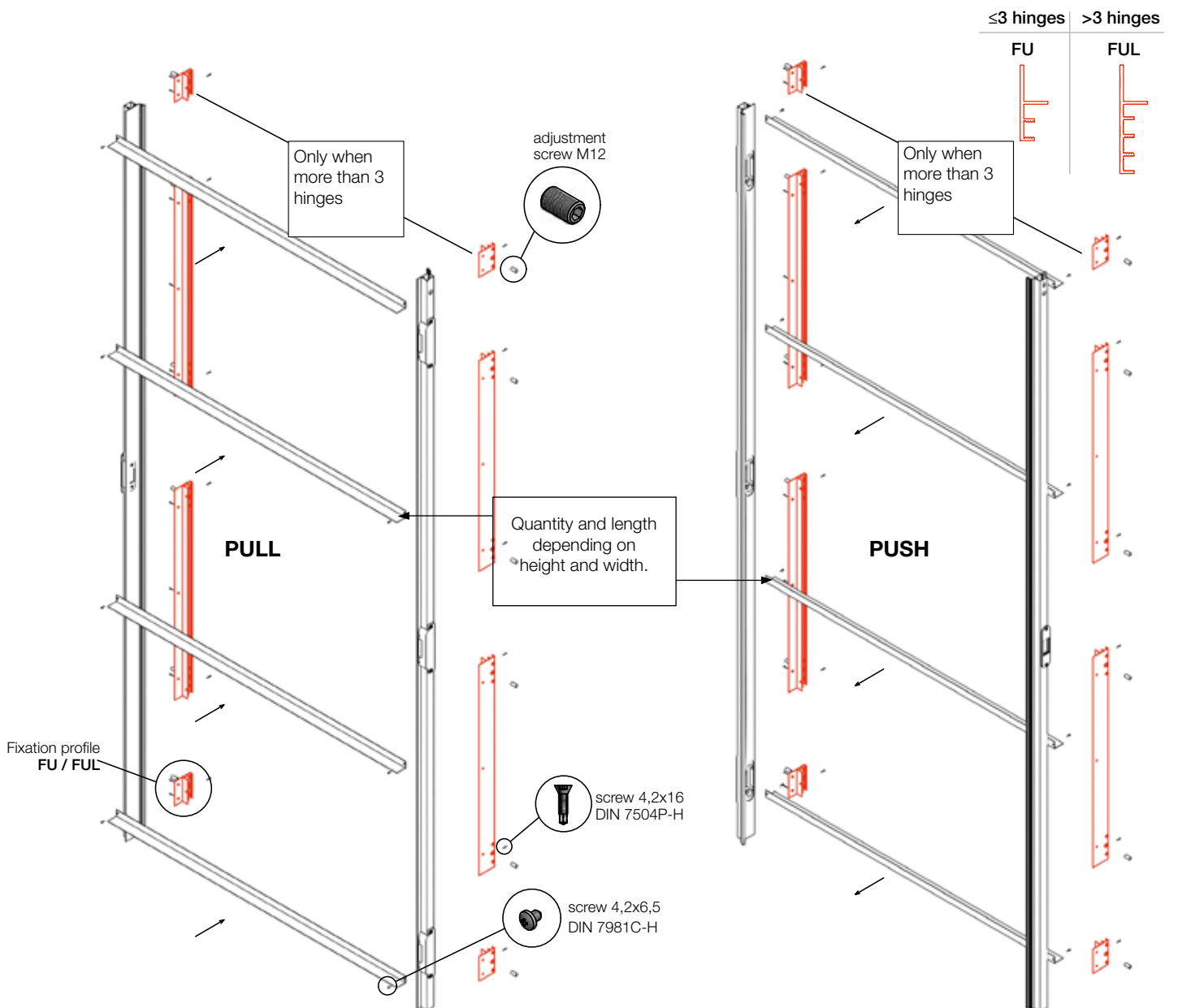
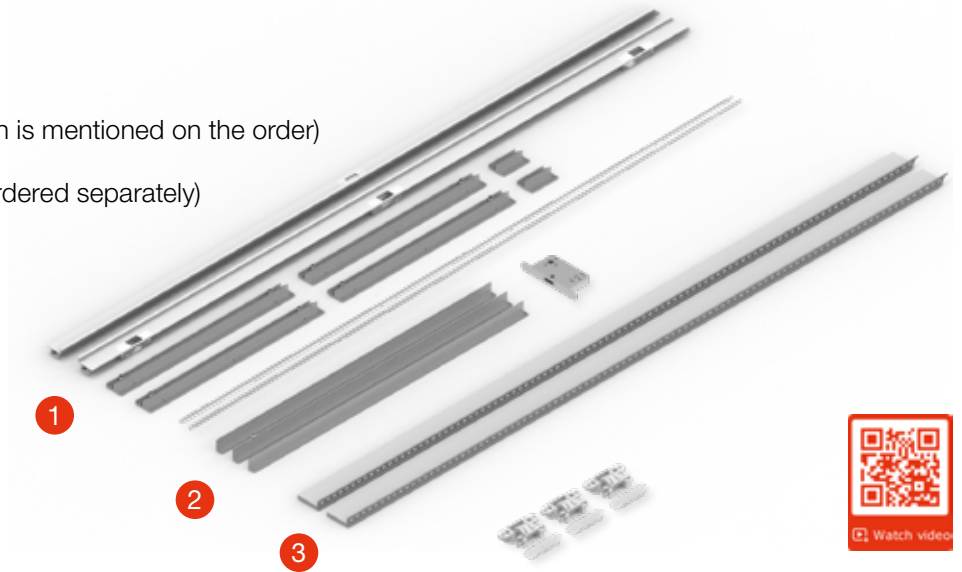



Generaal Deprezstraat 2/010  
8530 Harelbeke - Belgium

Tel.: +32 (0) 56 73 50 00  
Fax: +32 (0) 56 72 02 70

[info@xinnix.eu](mailto:info@xinnix.eu)  
[www.xinnix.eu](http://www.xinnix.eu)